

REVISIONS			
REV.	DESCRIPTION	DATE	BY

Marking:

Bag and Tag with Part Number, Serial Number and Date Code.

Classification

MIL-PRF-27 Grade: 6
MIL-PRF-27 Class: S (130° C)
Maximum Ambient Temperature: 105° C

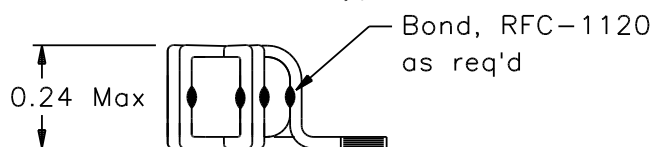
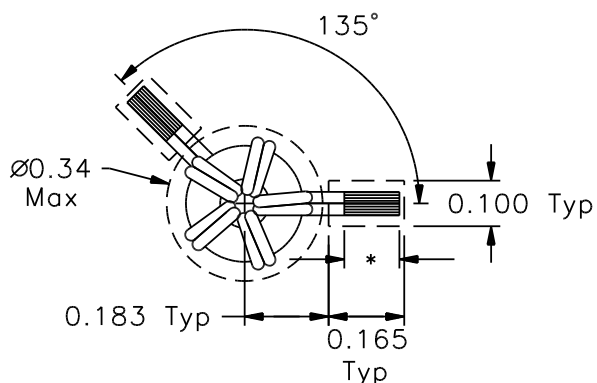

* strip and solder coat 0.12 Min. within indicated areas.

MIL-STD-981 Quality Assurance Provisions

Class	Description	Drawing Number ¹
C	Commercial Parts	33092-30
B	Group A Inspection	33092-31B
E	Group A Inspection	33092-31S
S	Group A Inspection	33092-31S and
	Group B Inspection	33092-85

¹ The germane data will ship with the hardware.

Maximum Operating Load Conditions	
IDC = 5.5 A	
P _{TOTAL} < 0.2 W	

Electrical Characteristics

DC Resistance = 6.5 mΩ Maximum

Inductance = 27.5 μH Nominal

These Parts Are Manufactured in Strict Compliance to MIL-STD-981.

The "X" in the part number refers to the Quality Level (C, B, E, or S), see Quality Assurance Provisions above.	UNLESS OTHERWISE SPECIFIED: Dimensions are in inches, and tolerances are:		COAST/ACM		
	Fractions ±1/64	Decimals .XX = ±0.03 .XXX = ±0.010	Angles ±5°	TITLE Saturable Reactor	
	DRAWN BY Jim Allen	DATE 3/19/04	FSCM 22558	DWG. NO 33092X	REV.
DO NOT SCALE DRAWING			SCALE: none	MAX. WT.: 1.5 gram	SHEET 1 OF 1